



National Products Inc.

## 2021 | **Honeywell** MOUNTING SOLUTIONS



Field Service . Healthcare . Manufacturing . Retail . Transportation . Warehouse



**SEEN IN THIS PHOTO:**

**RAM-HOL-HON7U**

RAM® Form-Fit Powered Dock for  
Honeywell CT50, CT60 & CT60 XP

**RAM-B-407-C-202-PUMPU**

RAM® Tough-Wedge™ Mount with  
Round Plate & Expansion Pouch

# TABLE OF CONTENTS

## HANDHELD PC



CT50, CT60 & CT60 XP

## 03 HANDHELD PC DOCKS



CN75 & CN75E



CN80



CT40 SERIES



EDA61K



SCANPAL EDA51

## 11 UNIVERSAL HOLDERS

## SCANNERS



CK65



HYPERION 1300G



CK75



SG20T



GRANIT SERIES



VOYAGER SERIES



HH660



XENON XP SERIES

## 05 SCANNER HOLDERS

## MOBILE PRINTERS



APEX 3



RL4E



APEX 4



RP4E



RL3E

## 06 MOBILE PRINTER HOLDERS

## TABLET PC



RT10 RUGGED TABLET

## 07 RUGGED TABLET DOCKS



SCANPAL EDA71

## 11 UNIVERSAL HOLDERS

## VEHICLE MOUNT COMPUTERS



THOR VM1A



THOR VM3A



THOR VM3



THOR CV31

## 09 VEHICLE MOUNT COMPUTER SOLUTIONS

## POPULAR KITS

14

# HANDHELD PC DOCKS

## POWERED DOCKS FOR HONEYWELL CT50, CT60 & CT60 XP

RAM® Mounts offers a wide variety of ruggedized mounting solutions for Honeywell mobile computers, printers, barcode scanners and more. Utilizing our form-fitting cradle design, securing your device wherever you need it has never been easier. The versatility of the RAM® mounting system allows you to efficiently move your device between your car, desk, forklift, and much more. Allowing for near-infinite adjustability as well as vibration damping, the RAM® double ball and socket system provides maximum versatility and helps to extend the life of these devices.

### HANDHELD PC DOCKS

#### POWERED DOCKS FOR HONEYWELL CT50, CT60 & CT60 XP



**RAM-HOL-HON7U**  
Non-Locking

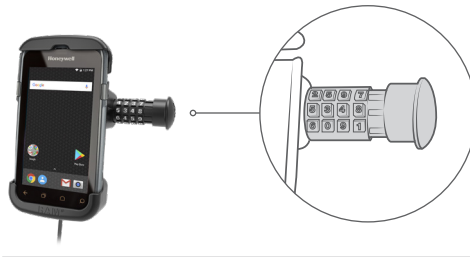

**RAM-HOL-HON7CLU**  
Combo-Locking

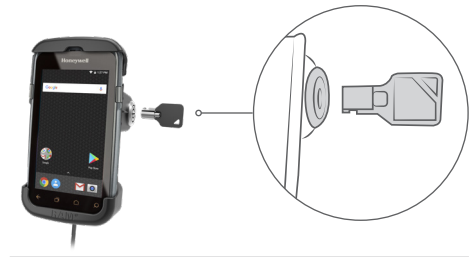

**RAM-HOL-HON7KLU**  
Key-Locking

### CHARGING ACCESSORIES







**RAM-GDS-CHARGE-V7BU**  
GDS® Modular 8-40V  
Hardwire Charger with  
Female USB Type A Connector

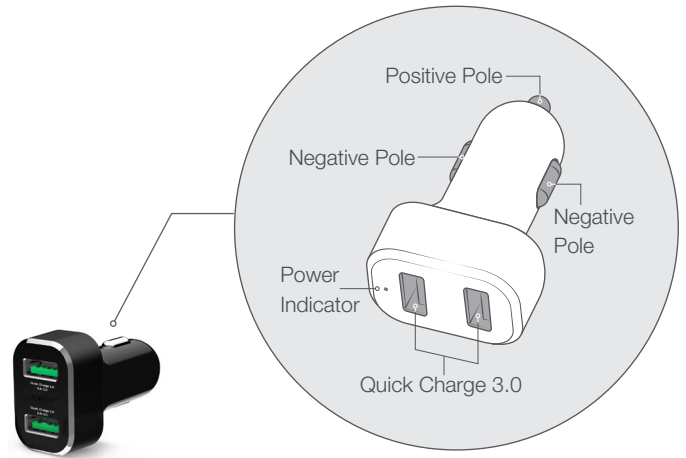

**RAM-GDS-CHARGE-USB2W**  
GDS® 2-Port USB Wall Charger



**RAM-GDS-CHARGE-USB2QCCIG**  
GDS® 2-Port USB Cigarette Charger with Qualcomm® Quick Charge™

HANDHELD PC DOCKS					
PART NUMBER	DEVICE	 NON-LOCKING	 COMBO LOCKING	 KEY LOCKING	 POWER CONNECTOR
RAM-HOL-HON7U	Honeywell CT50 & CT60	•			USB Type A
RAM-HOL-HON7CLU	Honeywell CT50 & CT60		•		USB Type A
RAM-HOL-HON7KLU	Honeywell CT50 & CT60			•	USB Type A

1

**SPRING-LOADED CRADLE WITH STYLUS HOLDER**

Allows you to secure your Honeywell

2

**LOCKING OPTIONS**

Available in combo-locking, key-locking and non-locking

3

**LEAF SPRING CONTACTS**

Integrated leaf spring contacts provide a reliable connection to the device's charging contacts to allow charging and maintain a low contact resistance

4

**CHARGING CAPABILITIES**

Includes a 1.25 meter USB Type A Male cable

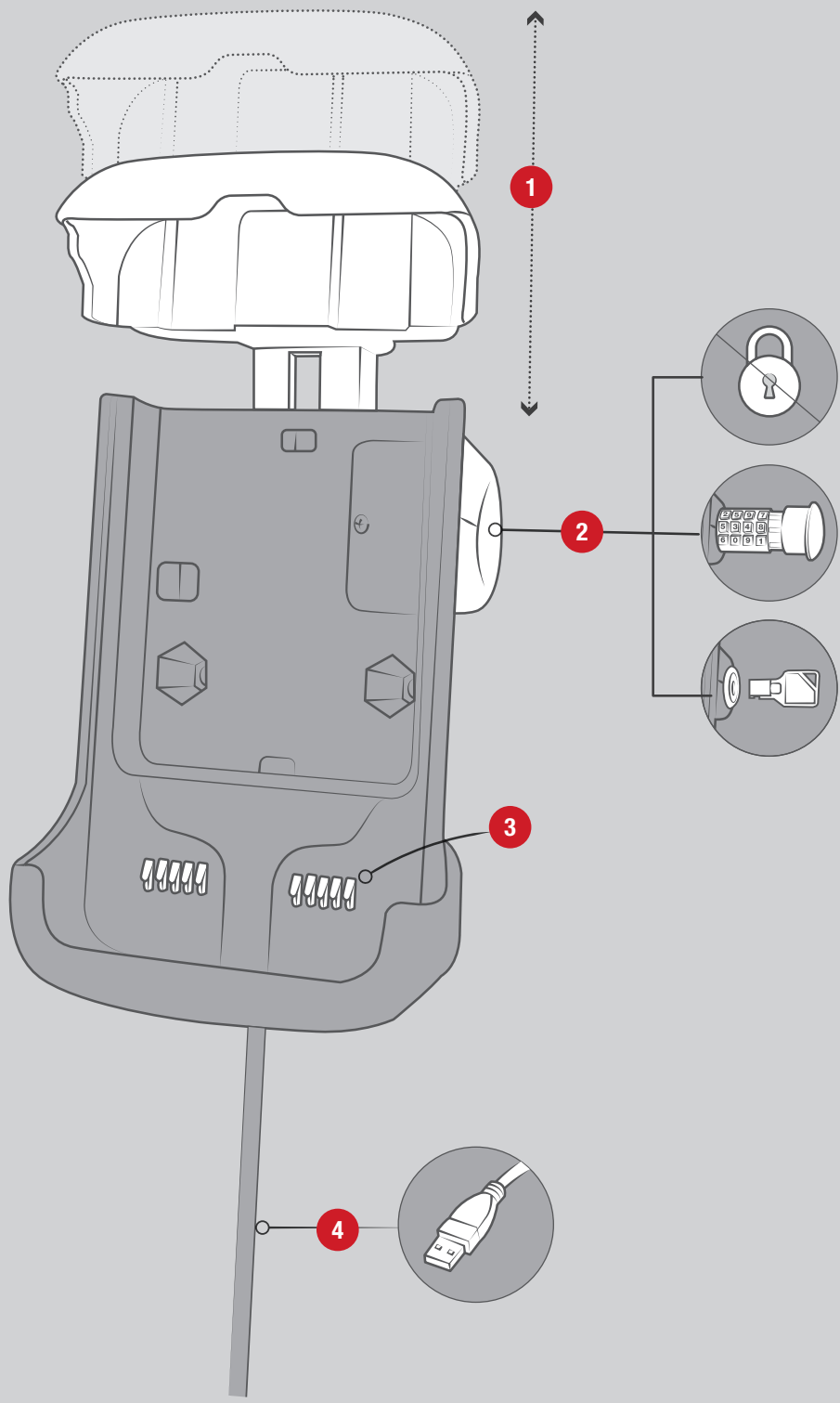

# SCANNER HOLDERS

Different types of scanner guns need different types of mounting solutions. Between the RAM® Drop-N-Lock™ and the RAM® Power-Grip™, we have effectively provided holders that cover a wide variety of scanner guns of different shapes and sizes. All RAM® Mounts Compatible™, these scanner gun holders have thoughtful design choices such as elastomeric fins that keep the scanner in place but are easy to remove when working fast.

## XENON XP DOCK MOUNT



### RAP-202U-HON2

C Size Ball Adapter for Honeywell Xenon XP Series Dock



### RAP-B-202U-HON2

B Size Ball Adapter for Honeywell Xenon XP Series Dock

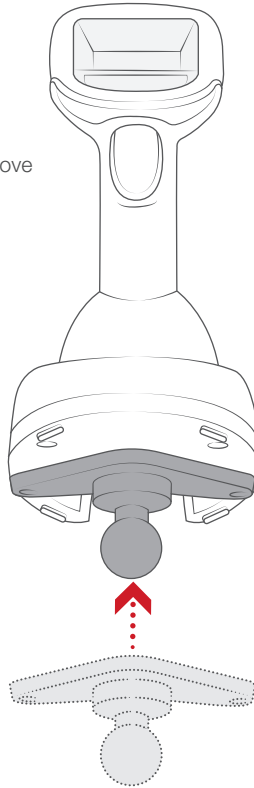

## RAM® POWER-GRIP™

Features replaceable elastomeric fins for a secure fit

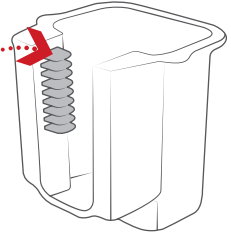

**BEST  
SELLER**



### RAP-450U

RAM® Power-Grip™ XL Scanner Gun Holder



### RAP-396U

RAM® Power-Grip™ Scanner Gun Holder

## RAM® DROP-N-LOCK™



### RAP-317U

RAM® Drop-N-Lock™ Scanner Gun Holder

## SCANNER GUN COMPATIBILITY GUIDE

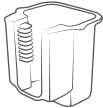
MODEL	 RAM® DROP-N-LOCK™	 RAM® POWER-GRIP™
CK65	-	RAP-450U
CK75	-	RAP-450U
Granit Series	-	RAP-396U
HH660	RAP-317U	RAP-396U
Hyperion 1300g	RAP-317U	RAP-396U
SG20T	RAP-317U	RAP-396U
Voyager Series	RAP-317U	RAP-396U



CK65



CK75



GRANIT  
SERIES



HH660



HYPERION  
1300G



SG20T



VOYAGER  
SERIES

1

**RAM-101U-247-4**

RAM® 4" Square Post Clamp Mount with Round AMPS Plate

2

**RAM-VPR-104**

RAM® Quick-Draw™ Jr. Universal Small Printer Holder

3

**RL4E**

Honeywell Mobile Label Printer

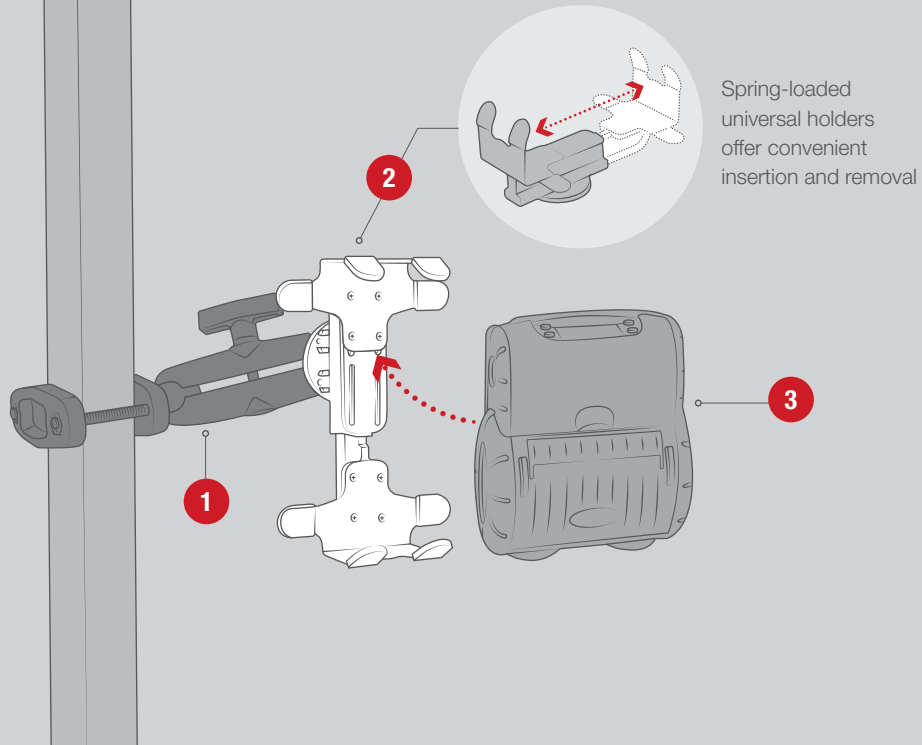

Spring-loaded universal holders offer convenient insertion and removal

# PRINTER HOLDERS

RAM® Mounts always doubles down on universal mounting solutions, and Honeywell printers provide a convenient shape to house such mounting solutions. Our RAM® Quick-Draw™ Jr. holders utilize spring-loaded grips that extend to fit nearly any size of Honeywell printers. Pair these holders with any B or C size RAM® mounting components for the ideal kit in the field service and material handling spaces.



**RAM-VPR-105**  
RAM® Quick-Draw™ Jr. Universal Printer Holder



**RAM-VPR-104**  
RAM® Quick-Draw™ Jr. Universal Small Printer Holder

MODEL	PART ID
RP4e Series	RAM-VPR-105
RL3e	RAM-VPR-104
RL4e	RAM-VPR-104
Apex 3	RAM-VPR-104
Apex 4	RAM-VPR-104

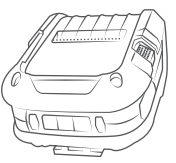

RP4E SERIES



RL3E



RL4E

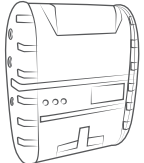

APEX 3

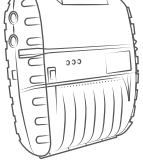

APEX 4

# RUGGED TABLET DOCKS

To conquer everyday tasks in the warehouse, in the field, or on the front lines, RAM® Mounts rugged mounting solutions enable Honeywell's versatile tablets to make the ideal pairing. Explore the new RAM® Power + Data docks for the Honeywell RT10 rugged tablet with many different options to keep your device connected to power and add peripherals to your solution such as scanners, printers, speakers and more.

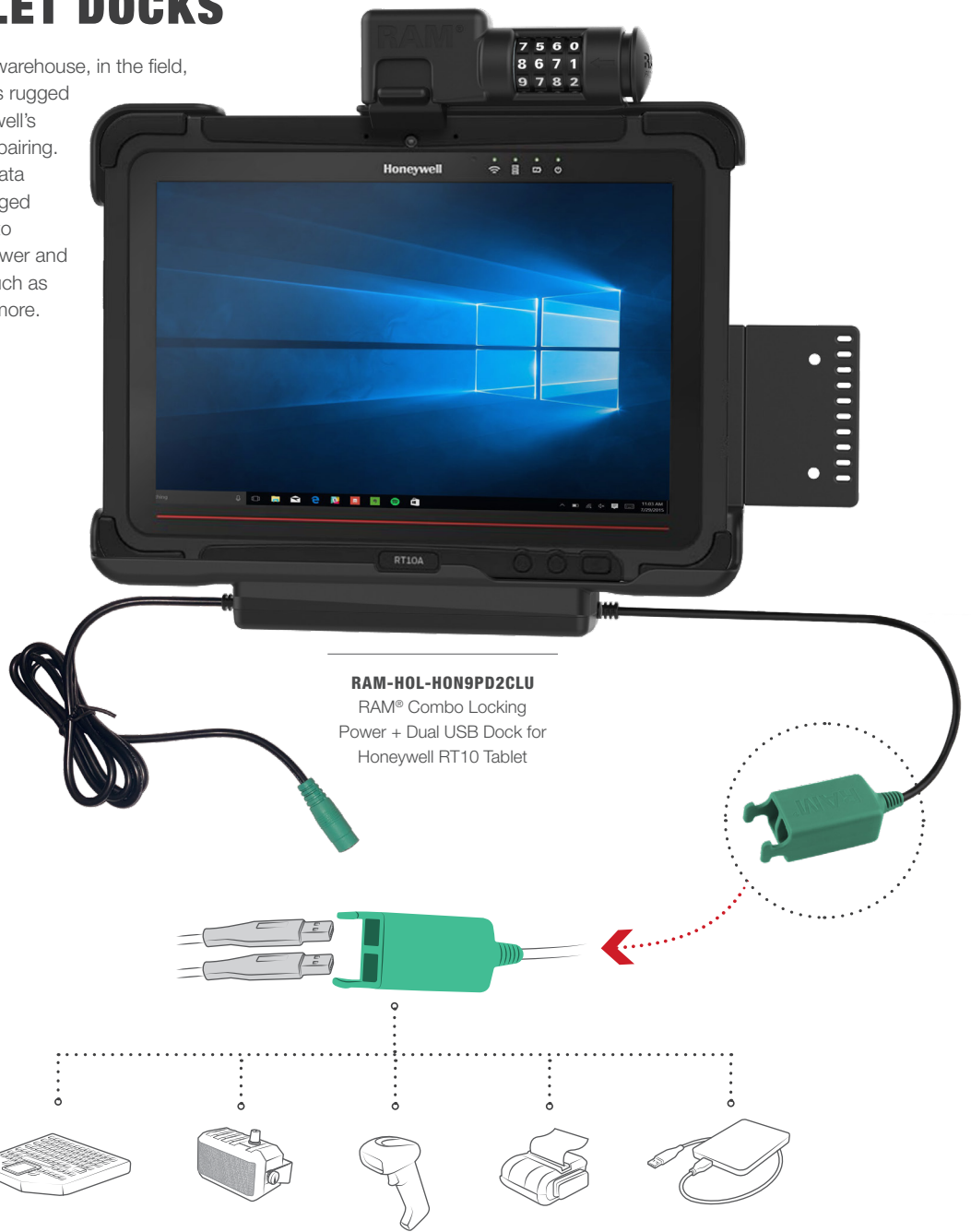

**RAM-HOL-HON9PD2CLU**  
 RAM® Combo Locking  
 Power + Dual USB Dock for  
 Honeywell RT10 Tablet

## KITS



**RAM-D-101U-C-247-4**  
 RAM® 4" Square Post Clamp Mount with  
 Round AMPS Plate

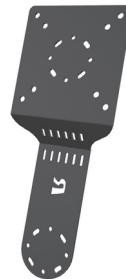

**RAM-DIS-103-2U**  
 RAM® Standard Accessory/Display Bracket



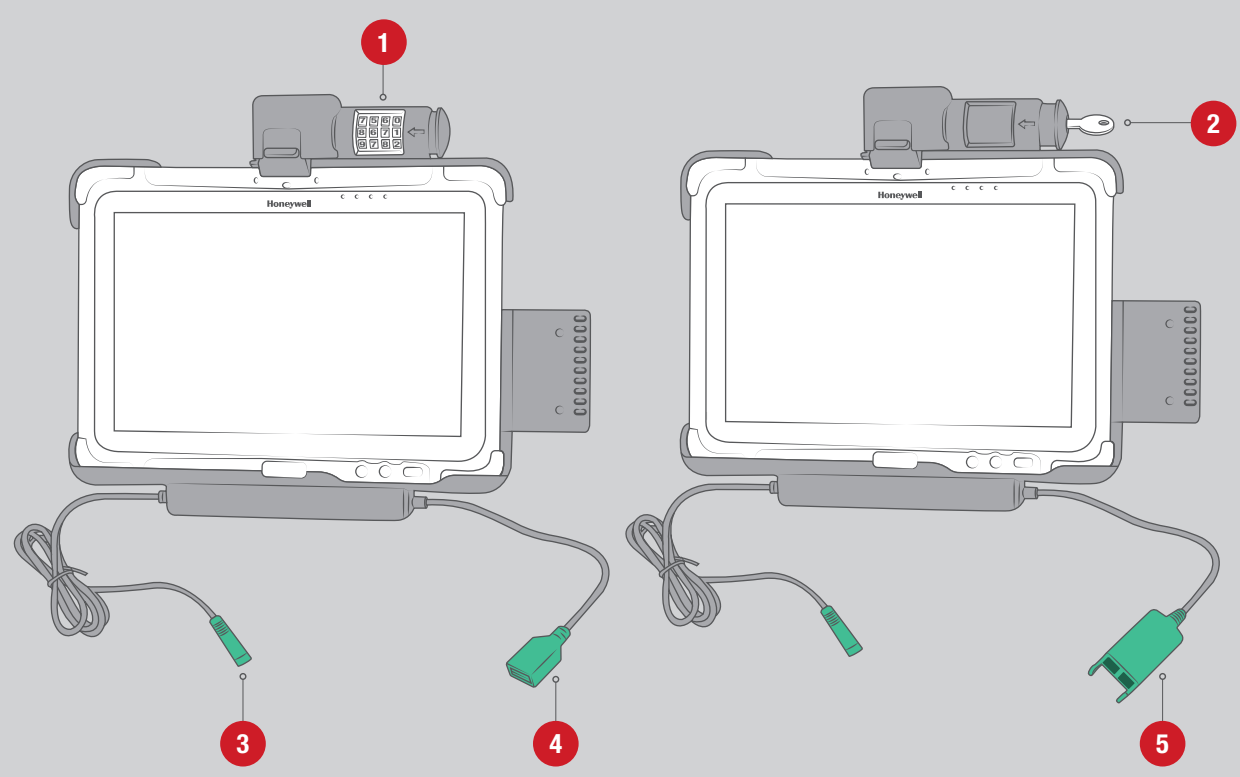

HONEYWELL RT10 RUGGED TABLET					
PART NUMBER	1  COMBO LOCKING	2  KEY LOCKING	3  POWERED	4  SINGLE USB PERIPHERAL PORTS	5  DUAL USB PERIPHERAL PORTS
RAM-HOL-HON9U					
RAM-HOL-HON9CLU	•				
RAM-HOL-HON9KLU		•			
RAM-HOL-HON9PU			•		
RAM-HOL-HON9PCLU	•		•		
RAM-HOL-HON9PKLU		•	•		
RAM-HOL-HON9PDU			•	•	
RAM-HOL-HON9PDCLU	•		•	•	
RAM-HOL-HON9PDKLU		•	•	•	
RAM-HOL-HON9PD2U			•		•
RAM-HOL-HON9PD2CLU	•		•		•
RAM-HOL-HON9PD2KLU		•	•		•

# VEHICLE MOUNT COMPUTER SOLUTIONS

Build any heavy duty mount for your Honeywell Vehicle Mount Computer by selecting any:

1

## CHOOSE A BALL ADAPTER

RAM® offers a wide selection of ball adapters and cradles for your specific device.

2

## CHOOSE A SOCKET ARM

Select a socket arm based on your desired length and placement.

3

## CHOOSE A BASE

Select from a variety of bases to help secure your device where you need it.

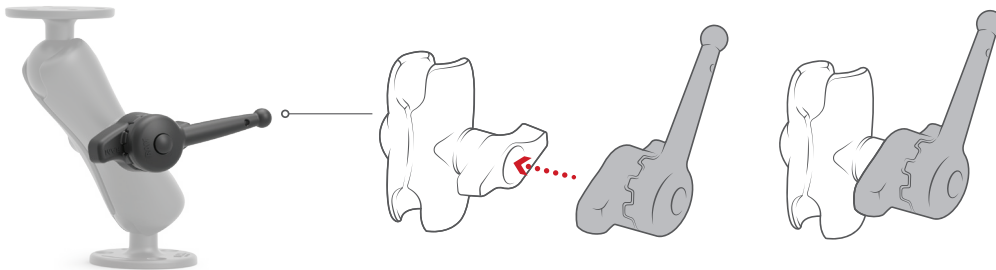

This wrench provides the extra leverage needed to tighten the mount in cold weather or in small spaces.

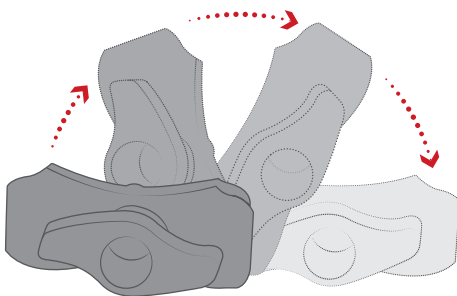

Double ball and socket technology allows for near-infinite adjustability of your RAM® mounting system

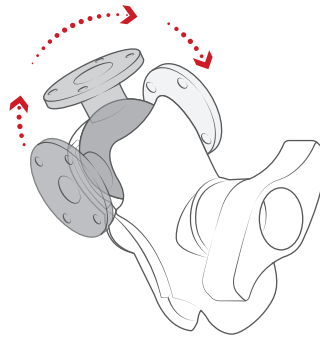

Included D size 2.25" RAM® rubber ball allows for connection to any D size RAM® double socket arm; ball and socket technology allows for near-infinite adjustability

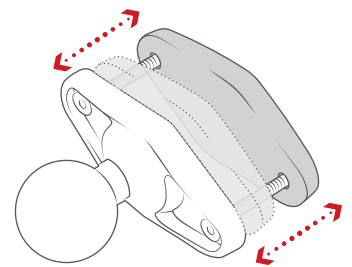

Easily adjustable

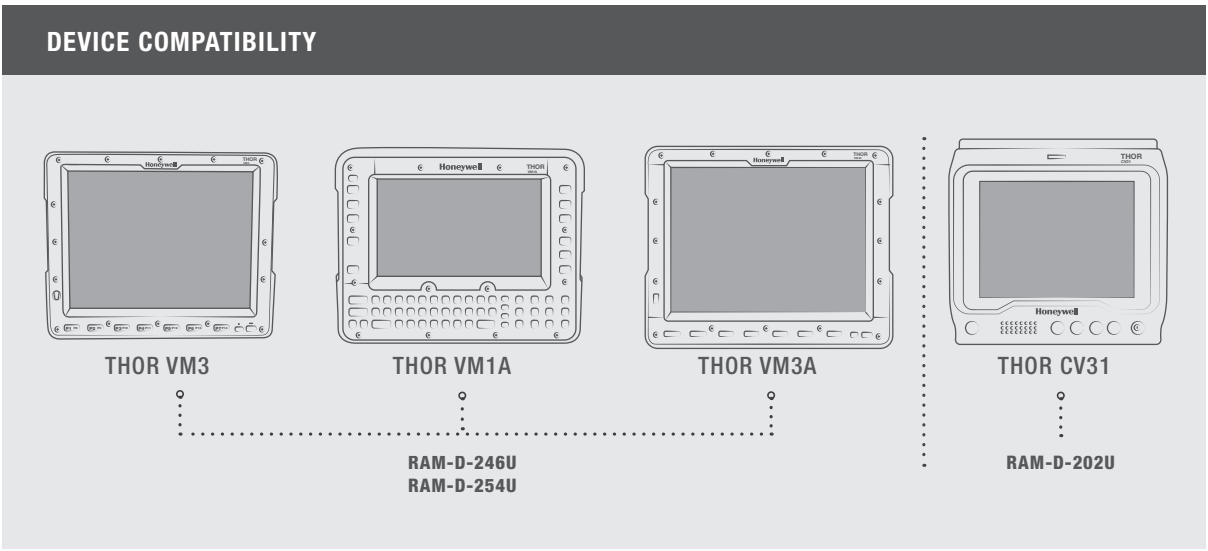

## 1 BALL ADAPTERS



## 2 SOCKET ARMS



## 3 BASES



# UNIVERSAL HOLDERS & MOUNTS

## RAM® FINGER-GRIP™

Doubling down on our “universal first” approach, handheld devices of all kind benefit from the patented RAM® Finger-Grip™, equipped with adjustable and movable “fingers” to modify the grip of the holder to accommodate various sizes of Honeywell handheld PC devices. Each flexible finger of the RAM® Finger-Grip™ moves to form perfectly around the device—simply push your device into the holder and the fingers expand to grip the device on all sides. Top and bottom leg supports are also adjustable based on the height of the device making this an ideal choice for a multitude of mobile device mounting

### DEVICE COMPATIBILITY



CT40  
SERIES



CN80



CN75 &  
CN75E



SCANPAL  
EDA51 HC



SCANPAL  
EDA51



RAM-HOL-UN4U  
RAM® Finger-Grip™

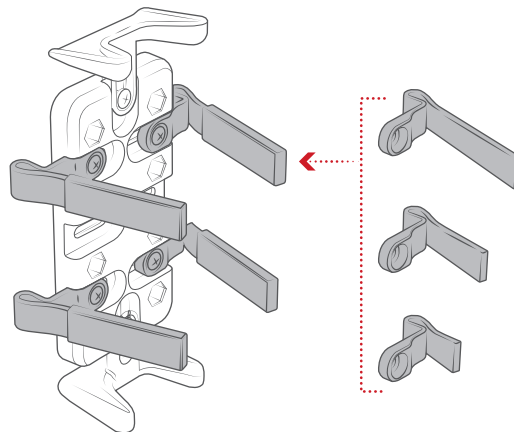

Different finger sizes to accommodate different device thicknesses

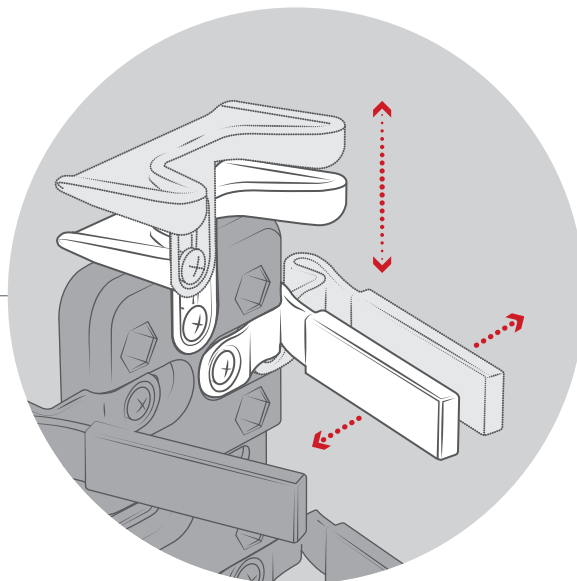
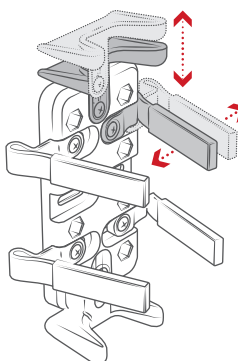

Universal holder with flexible rubber-coated fingers to provide a secure grip of your device; fingers open by squeezing the ends

## RAM® QUICK-DRAW™

RAM® printer cradles are the ideal solution for your mobile office, allowing you to mount a wide range of portable wireless printers in your vehicle. See the RAM® Quick-Draw™ holder for universal solutions as it expands to cradle your printer perfectly no matter what size it may be.

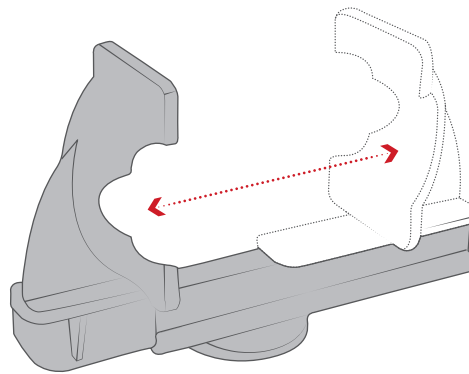

Adjustable side cups allow for supporting a wide variety of devices



**RAM-HOL-QD1U**  
 Fits Honeywell EDA61K

### DEVICE COMPATIBILITY



EDA61K

## RAM® X-GRIP®

Using a tablet for in-vehicle navigation and mobile work is on the rise. The RAM® X-Grip® for Tablets holds all the benefits and design features of the standard X-Grip® with added arm support for a variety of different size tablets with, or without a case. Additional grip handles provide side support for portrait, or landscape orientation, and are completely removable. Protect your investment with the highly rugged X-Grip® and be sure these holders stand the test of time in the harshest environments.

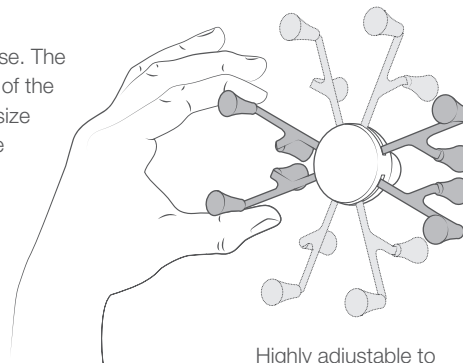

Highly adjustable to support tablets in portrait and landscape mode

### DEVICE COMPATIBILITY



SCANPAL  
 EDA71



**RAM-HOL-UN8BCU**  
 RAM® X-Grip® Universal Holder for 7"-8" Tablets with with C Size Ball



**RAM-HOL-UN8BU**  
 RAM® X-Grip® Universal Holder for 7"-8" Tablets with with B Size Ball

SEEN IN THIS PHOTO:

**RAM-D-271U-2**

Round Post Clamp with 2.25" Ball

**RAM-D-201U**

Standard Double Socket Arm for 2.25" Ball

**RAM-D-202U**

Device Adapter with 2.25" Ball (shown with Honeywell Thor CV31)

**RAM-202U-IN10**

Keyboard Adapter Plate

**RAM-202U**

AMPS Device Adapter with 1.5" Ball

**RAM-201U-B**

Short Double Socket Arm for 1.5" Ball





**SEEN IN THIS PHOTO:**

---

**RAM-247U-25**  
 Square Post Clamp with 1.5" Ball

**RAM-201U**  
 Standard Socket Arm for 1.5" Ball

**RAM-202U**  
 AMPS Device Adapter with 1.5" Ball

**RAP-396U**  
 RAM® Power-Grip™ Scanner Gun Holder  
 (shown with Honeywell Granit Series Scanner)

# POPULAR KITS



**RAM-B-166-UN4U**  
 RAM® Flat Surface Mount for Zebra Printer Docks



**RAM-B-138-UN4**  
 RAM® Finger-Grip™ Universal Mount with Drill-Down Base



**RAM-B-108-UN4**  
 RAM® Finger-Grip™ Universal Mount with Strap Hose Clamp Base



**RAM-B-247-3-UN4**  
 RAM® Finger-Grip™ Universal Holder with 3" Square Post Clamp Mount



**RAM-D-101U-C-247-4**  
 RAM® 4" Square Post Clamp Mount with Round AMPS Plate



**RAM-D-101-C-254U**  
 RAM® Double Ball Mount with Round AMPS Plate and Large Round Plate



**RAM-D-101-254U**  
 RAM® Double Ball Mount with Round AMPS Plate and Large Round Plate



**RAM-D-101U-C-IN1**  
 RAM® Universal Double Ball Mount with Two Steel Reinforced Round Plates



**RAM-VPR-105-1**  
 RAM® Quick-Draw™ Jr. with Double U-Bolt Base for Printers



**RAM-VPR-104-1**  
 RAM® Quick-Draw™ Jr. with Double U-Bolt Base for Small Printers



Mount Anything, Anywhere

**Honeywell**

rammount.com  
1.800.497.7479  
sales@rammount.com

